

## Flush pressure transmitter For viscous and particle-laden media Model S-11



for further approvals  
see page 6

### Applications

- General industrial applications
- Food and beverage industry
- Filling and packing machinery
- Dosing technology
- Level measurement

### Special features

- High-quality product
- Many configurations possible
- Flush process connection
- Large stocks for short delivery times
- Vacuum-tight



**Fig. left: Pressure transmitter model S-11**

**Fig. right: Pressure transmitter model S-11 with cooling element**

## Description

### Expert for viscous and particle-laden media

The model S-11 pressure transmitter with flush diaphragm has been specifically designed for the measurement of viscous, paste-like, adhesive, crystallising, particle-laden and contaminated media, which would clog the pressure channel of conventional process connections.

Through its optimised design, the flush process connection enables cleanability with the wetted diaphragm integrated into the process. Low-maintenance and trouble-free pressure measurement is thus also guaranteed in critical applications with frequently changing media.

High accuracy, a robust design, high-quality workmanship and the high flexibility of configuration are key features of the model S-11.

### Flush process connection

All process connections of the flush pressure transmitter are made of stainless steel and are fully welded and isolate the medium from the pressure measuring instrument via a positive seal. A reliable, dead-space free sealing between the process connection and the measuring medium is thus assured.

For high medium temperatures of up to 150 °C (302 °F), the pressure transmitter is also available with an integrated cooling element.

Specifically for the food and beverage industry, a version with internal system fill fluid in accordance with FDA 21 CFR 178.3750 can be chosen.

**Measuring ranges**

Gauge pressure								
bar	Measuring range	0 ... 0.1	0 ... 0.16	0 ... 0.25	0 ... 0.4	0 ... 0.6	0 ... 1	0 ... 1.6
	Overload safety	1	1.5	2	2	4	5	10
	Measuring range	0 ... 2.5	0 ... 4	0 ... 6	0 ... 10	0 ... 16	0 ... 25	0 ... 40
	Overload safety	10	17	35	35	80	50	80
	Measuring range	0 ... 60	0 ... 100	0 ... 160	0 ... 250	0 ... 400	0 ... 600	
	Overload safety	120	200	320	500	800	1,200	
psi	Measuring range	0 ... 15	0 ... 20	0 ... 30	0 ... 50	0 ... 60	0 ... 100	0 ... 150
	Overload safety	145	145	145	240	240	500	500
	Measuring range	0 ... 160	0 ... 200	0 ... 250	0 ... 300	0 ... 400	0 ... 500	0 ... 600
	Overload safety	1,160	1,160	1,160	1,160	1,160	1,160	1,160
	Measuring range	0 ... 750	0 ... 1,000	0 ... 1,500	0 ... 2,000	0 ... 3,000	0 ... 5,000	0 ... 6,000
	Overload safety	1,740	1,740	2,900	4,600	7,200	11,600	11,600

Absolute pressure								
bar	Measuring range	0 ... 0.25	0 ... 0.4	0 ... 0.6	0 ... 1	0 ... 1.6	0 ... 2.5	0 ... 4
	Overload safety	2	2	4	5	10	10	17
	Measuring range	0 ... 6	0 ... 10	0 ... 16				
	Overload safety	35	35	80				
psi	Measuring range	0 ... 15	0 ... 25	0 ... 50	0 ... 100	0 ... 250		
	Overload safety	72.5	145	240	500	1,160		

Vacuum and +/- measuring range						
bar	Measuring range	-0.6 ... 0	-0.4 ... 0	-0.25 ... 0	-0.16 ... 0	-0.1 ... 0
	Overload safety	4	2	2	1.5	1
	Measuring range	-1 ... 0	-1 ... +0.6	-1 ... +1.5	-1 ... +3	-1 ... +5
	Overload safety	5	10	10	17	35
	Measuring range	-1 ... +9	-1 ... +15	-1 ... +24		
	Overload safety	35	80	50		
psi	Measuring range	-30 inHg ... 0	-30 inHg ... +30	-30 inHg ... +60	-30 inHg ... +100	-30 inHg ... +160
	Overload safety	72.5	240	240	500	1,160
	Measuring range	-30 inHg ... +200	-30 inHg ... +300			
	Overload safety	1,160	1,160			

The given measuring ranges are also available in mbar, MPa and further units.

**Vacuum tightness**

Yes

## Output signals

### Output signal

Signal type	Signal
Current (2-wire)	4 ... 20 mA
Current (3-wire)	0 ... 20 mA
Voltage (3-wire)	DC 0 ... 10 V
	DC 0 ... 5 V

Other output signals on request.

### Load in $\Omega$

Depending on the signal type the following loads apply:

Current (2-wire):  $\leq (\text{power supply} - 10 \text{ V}) / 0.02 \text{ A}$

Current (3-wire):  $\leq (\text{power supply} - 3 \text{ V}) / 0.02 \text{ A}$

Voltage (3-wire):  $> \text{max. output signal} / 1 \text{ mA}$

## Voltage supply

### Power supply

The power supply depends on the selected output signal

4 ... 20 mA (2-wire): DC 10 ... 30 V

0 ... 20 mA (3-wire): DC 10 ... 30 V

DC 0 ... 10 V: DC 14 ... 30 V

DC 0 ... 5 V: DC 10 ... 30 V

## Reference conditions (per IEC 61298-1)

### Temperature

15 ... 25 °C (59 ... 77 °F)

### Atmospheric pressure

860 ... 1,060 mbar (12.5 ... 15.4 psi)

### Humidity

45 ... 75 % r. h.

### Power supply

DC 24 V

### Mounting position

Calibrated in vertical mounting position with process connection facing downwards.

## Accuracy specifications

### Accuracy at reference conditions

Accuracy	
Standard	$\leq \pm 0.5 \%$ of span
Option	$\leq \pm 0.25 \%$ of span <sup>1)</sup>

<sup>1)</sup> Only for measuring ranges  $\geq 0.25 \text{ bar}$

Including non-linearity, hysteresis, zero offset and end value deviation (corresponds to measured error per IEC 61298-2). Calibrated in vertical mounting position with process connection facing downwards.

### Non-linearity (per IEC 61298-2)

$\leq \pm 0.2 \%$  of span BFSL

### Non-repeatability

$\leq 0.1 \%$  of span

### Temperature error in rated temperature range

Rated temperature range:

0 ... 80 °C (32 ... 176 °F)

Mean temperature coefficient of zero point:

Measuring range  $> 0.25 \text{ bar}$ :  $\leq \pm 0.2 \%$  of span/10 K

Measuring range  $\leq 0.25 \text{ bar}$ :  $< \pm 0.4 \%$  of span/10 K

Mean temperature coefficient of span:

$\leq \pm 0.2 \%$  of span/10 K

### long-term stability at reference conditions

$\leq \pm 0.2 \%$  of span/year

### Adjustability of zero point and span

Adjustment is made using potentiometers inside the instrument.

Not possible for IP68 cable outlet.

Zero point:  $\pm 5 \%$

Span:  $\pm 5 \%$

## Time response

### Settling time

$\leq 2 \text{ ms}$

## Operating conditions

### Ingress protection (per IEC 60529)

The ingress protection depends on the type of electrical connection.

Electrical connection	Ingress protection
Angular connector DIN 175301-803 A	IP65
Circular connector M12 x 1 (4-pin)	IP67
Cable outlet IP67	IP67
Cable outlet IP68	IP68 <sup>1)</sup>

1) Adjustability of zero point and span not possible.

The stated ingress protection only applies when plugged in using mating connectors that have the appropriate ingress protection.

### Vibration resistance

Process connections without cooling element:  
20 g (IEC 60068-2-6, under resonance)

Process connections with cooling element:  
10 g (IEC 60068-2-6, under resonance)

### Shock resistance

Process connections without cooling element:  
1,000 g (IEC 60068-2-27, mechanical)

Process connections with cooling element:  
400 g (IEC 60068-2-27, mechanical)

### Permissible temperature ranges

Also meets EN 50178, tab. 7, operation (C) 4K4H, storage (D) 1K4, transport (E) 2K3.

Process connections without cooling element		
Medium		
■ Standard	-30 ... +100 °C	-22 ... +212 °F
■ Option	-30 ... +125 °C	-22 ... +257 °F
Ambient	-20 ... +80 °C	-4 ... +176 °F
Storage	-40 ... +100 °C	-40 ... +212 °F

Process connections with cooling element		
Medium	-20 ... +150 °C	-4 ... +302 °F
Ambient	-20 ... +80 °C	-4 ... +176 °F
Storage	-40 ... +100 °C	-40 ... +212 °F

## Electrical connections

### Short-circuit resistance

S+ vs. U-

### Reverse polarity protection

U+ vs. U-

### Overvoltage protection

DC 36 V

### Insulation voltage

DC 500 V with NEC class 02 voltage supply (low voltage and low current max. 100 VA even under fault conditions)

## Connection diagrams

Angular connector DIN 175301-803 A			
		2-wire	3-wire
	U+	1	1
	U-	2	2
	S+	-	3
Wire cross-section max. 1.5 mm <sup>2</sup> (AWG 16) Cable diameter 6 ... 8 mm (0.24 ... 0.31")			

Circular connector M12 x 1 (4-pin)			
		2-wire	3-wire
	U+	1	1
	U-	3	3
	S+	-	4

Cable outlet			
		2-wire	3-wire
	U+	brown (BN)	brown (BN)
	U-	green (GN)	green (GN)
	S+	-	white (WH)
	Shield	grey (GY)	grey (GY)
Wire cross-section 6 x 0.5 mm <sup>2</sup> (AWG 20) Cable diameter 6.8 mm (0.27") Cable lengths 1.5 m, 3 m, 5 m, 10 m, 15 m (4.9 ft, 9.8 ft, 16.4 ft, 32.8 ft, 49.2 ft)			

Other connections on request.

## Process connections

Thread	Available measuring ranges	
G ½ B flush <sup>1)</sup>	0 ... 2.5 to 0 ... 600 bar	0... 50 to 0 ... 6,000 psi
G 1 B flush <sup>1)</sup>	0 ... 0.1 to 0 ... 1.6 bar	0 ... 15 psi
Hygienic G 1 B flush (in accordance with 3-A Sanitary Standards)	0 ... 0.1 to 0 ... 25 bar	0 ... 15 to 0 ... 300 psi

1) Process connection also available with cooling element.

## Cooling elements

For higher medium temperatures, process connections with a cooling element are available (see "Operating conditions").

## Sealing

Process connection	Max. medium temperature	Sealing material and max. pressure limitation		
		Standard	Option 1	Option 2
without cooling element	up to 100 °C (212 °F)	NBR up to 600 bar (8,700 psi)	FKM/FPM <sup>1)</sup> up to 600 bar (8,700 psi)	EPDM up to 200 bar (2,900 psi)
	up to 125 °C (257 °F)	NBR up to 600 bar (8,700 psi)	FKM/FPM <sup>1)</sup> up to 400 bar (5,800 psi)	EPDM up to 200 bar (2,900 psi)
with cooling element	up to 150 °C (302 °F)	FKM/FPM <sup>1)</sup> up to 300 bar (4,350 psi)	EPDM up to 200 bar (2,900 psi)	-
Hygienic	up to 150 °C (302 °F)	EPDM up to 200 bar (2,900 psi)	-	-

1) Minimum permissible medium and ambient temperature -20 °C / -4 °F

O-ring for G ½ B flush process connection optionally available with FFKM seal material (pressure limitation 600 bar (8,700 psi) for all medium temperatures)

The sealings listed under "Standard" are included in the delivery.

## Materials









### Wetted parts

- G ½ B and G 1 B flush: 316Ti
- G 1 B flush, hygienic: 316L
- For sealing materials see "Process connections"

### Internal pressure transmission medium

Pressure transmission medium	
Standard	Synthetic oil
Option	Food-compatible system fill fluid per FDA 21 CFR 178.3750

## Approvals

Logo	Description	Country
	<b>EU declaration of conformity</b> <ul style="list-style-type: none"> <li>■ EMC directive <sup>1)</sup></li> <li>EN 61326 emission (group 1, class B) and interference immunity (industrial application)</li> <li>■ Pressure equipment directive</li> <li>■ RoHS directive</li> </ul>	European Community
	<b>CSA</b> Safety (e.g. electr. safety, overpressure, ...)	Canada
	<b>EAC</b> Electromagnetic compatibility	Eurasian Economic Community
	<b>GOST</b> Metrology, measurement technology	Russia
	<b>KazInMetr</b> Metrology, measurement technology	Kazakhstan
-	<b>MTSCHS</b> Permission for commissioning	Kazakhstan
	<b>BelGIM</b> Metrology, measurement technology	Belarus
	<b>Uzstandard</b> Metrology, measurement technology	Uzbekistan
	<b>3-A</b> Sanitary Standard  <small>only for instruments with process connection hygienic G 1 B            This instrument is 3-A marked, based on a third party verification for conformance to the 3-A standard.</small>	USA

1) The existence of strong electromagnetic fields in a frequency range of < 2.7 GHz can result in increased measuring errors up to 1 %. Do not install the instruments in the vicinity of strong electromagnetic sources of interference (e.g. transmitting devices, radio equipment), or use sheath current filters where applicable.

## Manufacturer's information and certifications

Logo	Description
-	<b>China RoHS directive</b>
-	<b>MTTF &gt; 100 years</b>

Approvals and certificates, see website

## Dimensions in mm (inch)

### Pressure transmitter

with angular connector DIN 175301-803 A

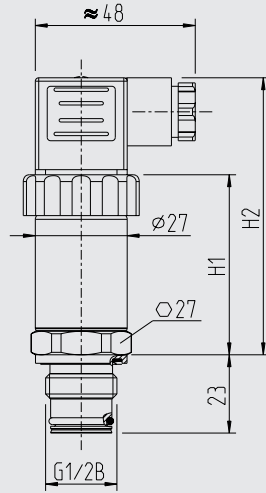

Weight approx. 0.2 kg / 7 oz

with M12 x 1 circular connector

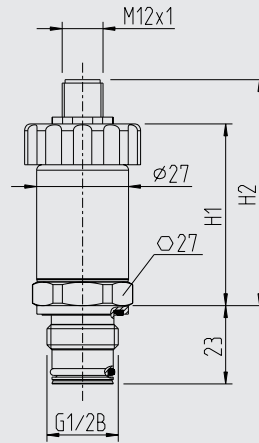

Weight approx. 0.2 kg / 7 oz

with cable outlet IP67

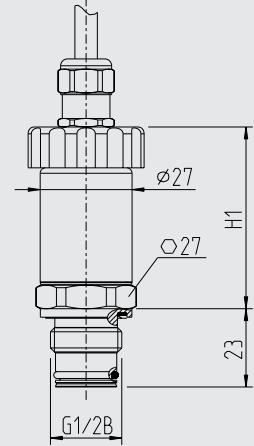

Weight approx. 0.2 kg / 7 oz

with cable outlet IP68

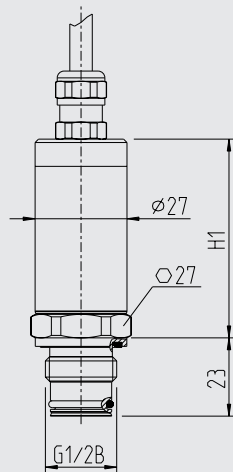

Weight approx. 0.2 kg / 7 oz

with cooling element for medium temperatures up to 150 °C

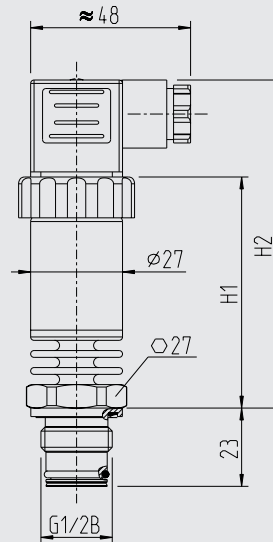

Weight approx. 0.3 kg / 10 oz

with cooling element for medium temperatures up to 150 °C and hygienic process connection

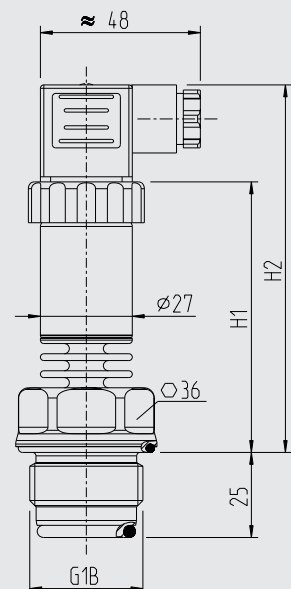

Weight approx. 0.5 kg / 18 oz

Electrical connection	Dimension	Process connection		
		G ½ B, G 1 B		G 1 hygienic
		without cooling element	with cooling element	with cooling element
Angular connector DIN 175301-803 A	H1	54 (2.13)	69 (2.72)	80 (3.15)
	H2	83.5 (3.29)	98 (3.56)	109 (4.29)
Circular connector M12 x 1	H1	54 (2.13)	69 (2.72)	80 (3.15)
	H2	67 (2.64)	82 (3.23)	93 (3.66)
Cable outlet IP67	H1	54 (2.13)	69 (2.72)	80 (3.15)
Cable outlet IP68	H1	58 (2.28)	73 (2.87)	84 (3.31)

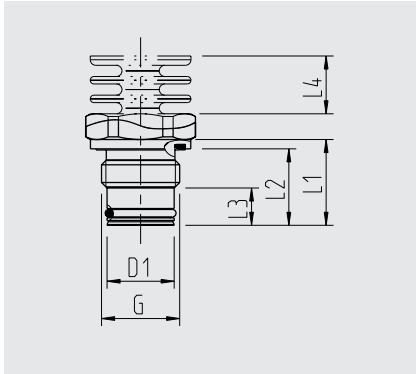
**Process connections**

G	D1	L1	L2	L3	L4
G 1/2 B	18 (0.71)	23 (0.91)	20.5 (0.81)	10 (0.4)	15.5 (0.61)

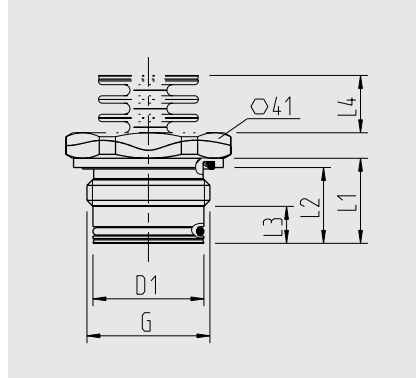

G	D1	L1	L2	L3	L4
G 1 B	30 (1.19)	23 (0.91)	20.5 (0.81)	10 (0.4)	15.5 (0.61)

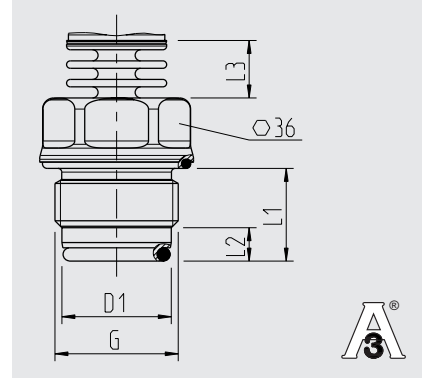

G	D1	L1	L2	L3
G 1 B hygienic	29.5 (1.17)	25 (0.99)	9 (0.36)	15.5 (0.61)

Surface roughness of wetted metallic parts, Ra ≤ 0.76 µm

 For information on tapped holes and welding sockets, see Technical information IN 00.14 at [www.wika.com](http://www.wika.com).

**Accessories**
**Welding socket**

	Designation	Order number
	Welding socket for G 1/2 B flush	1192299
	Welding socket for G 1 B flush	1192264
	Welding socket for G 1 B hygienic flush	14145179
	Welding socket for G 1 B hygienic flush with leak-control channel Fulfils the 3-A Sanitary Standards	14145183

For further adapter systems for measuring instruments with G 1 B hygienic process connection, see data sheet AC 09.20.

**Mating connector**

Designation	Order number			
	without cable	2 m cable, shielded	5 m cable, shielded	10 m cable, shielded
Angular connector DIN 175301-803 A				
■ with cable gland, metric	11427567	14100465	14100466	-
■ with cable gland, conduit	11022485	-	-	-
Circular connector M12 x 1 (4-pin)				
■ straight	-	14086880	14086883	14086884
■ angled	-	14086889	14086891	14086892



**Sealings for mating connectors**

Mating connector	Order number	
	Blue (WIKA)	Brown (neutral)
Angular connector DIN EN 175301-803 A	1576240	11437902

**Sealings for process connection**

Thread size and sealing	Order number			
	NBR	FPM/FKM	EPDM	FKKM
G ½ B				
■ O-ring	14072275	14072276	14072277	14073739
■ Profile sealing	1039067	1039075	1538306	-
G 1 B				
■ O-ring	1108247	1099094	1535056	-
■ Profile sealing	1100386	1145967	11522381	-
G 1 B hygienic				
■ O-ring	-	-	2225859	-
■ Profile sealing	-	-	11522381	-